

NON-ISOLATED DC/DC CONVERTERS

8.3 V-14 V Input

0.75 V-5.0 V/10 A Output

bel
POWER PRODUCTS

SRBC-10A2Ax Series

RoHS Compliant

- Non-Isolated
- High Efficiency
- High Power Density
- Excellent Thermal Performance
- Low Cost
- Flexible Output Voltage Sequencing
- Remote Sense
- Able to Sink/Source Current
- Under-voltage Lockout (UVLO)
- Over Temperature Protection
- OCP/SCP
- Wide Input
- Wide Trim
- Remote On/Off
- Active Low/High (option)
- Industrial Temperature Range



Description

The Bel SRBC-10A2Ax modules are a series of non-isolated dc/dc converters that deliver up to 10 A of output current with full load efficiency of 93% at 3.3 V output. These modules provide precisely regulated voltage programmable via external resistor from 0.75 V to 5.0 V over a wide range of input voltage (8.3 V-14 V). These modules have a sequencing feature that enables designers to implement various types of output voltage sequencing when powering multiple voltages on a board. The open-frame construction and small footprint enable designers to develop cost and space-efficient solutions. Standard features include remote On/Off, over current protection, short current protection, wide input, and programmable output voltage.

Part Selection

Output Voltage	Input Voltage	Max. Output Current	Max. Output Power	Typical Efficiency	Model Number Active Low	Model Number Active High
0.75 V - 5.0 V	8.3 V - 14 V	10 A	50.0 W	95%	SRBC-10A2AL	SRBC-10A2A0

Note: Add "G" suffix at the end of the model number to indicate "Tray Packaging".

Absolute Maximum Ratings

Parameter	Min	Typ	Max	Notes
Input Voltage (continuous)	-0.3 V	-	15 V	
Output Enable Terminal Voltage	-0.3 V	-	15 V	
Sequencing Voltage ¹	-0.3 V	-	V _{in}	
Ambient Temperature	-40 °C	-	85 °C	
Storage Temperature	-55 °C	-	125 °C	

Notes: All specifications are typical at 25 °C unless otherwise stated.

1. SRBC-10A2Ax series of modules include a sequencing feature that enables users to implement various types of output voltage sequencing in their applications. This is accomplished via an additional sequencing pin. When the sequencing feature is not used, tie the SEQ pin to V_{in} or leave it unconnected.

NON-ISOLATED DC/DC CONVERTERS

8.3 V-14 V Input

0.75 V-5.0 V/10 A Output



Input Specifications

Parameter	Min	Typ	Max	Notes
Input Voltage				
Vo, set ≤ 3.63 V	8.3 V	12 V	14 V	
Vo, set > 3.63 V	8.3 V	12 V	13.2 V	
Input Current (full load)	-	-	6.5 A	An input line fuse must always be used.
Input Current (no load)	-	50 mA	-	
Remote Off Input Current	-	2 mA	-	
Input Reflected Ripple Current (pk-pk)	-	-	400 mA	Tested with one 1000 uF/25 V AL input capacitor with ESR=0.03 ohm max and 4 × 47 uF/16 V tan capacitors with ESR=0.013 ohm max at 100 kHz, & simulated source impedance of 1000 nH, 5 Hz to 20 MHz.
Input Reflected Ripple Current (rms)	-	-	150 mA	
I ² t Inrush Current Transient	-	0.04 A ² s	0.08 A ² s	
Turn-on Voltage Threshold	-	8.2 V		
Turn-off Voltage Threshold	-	7.9 V		

Note: All specifications are typical at 25 °C unless otherwise stated.

Output Specifications

Parameter	Min	Typ	Max	Notes	
Output Voltage Set Point	-2% Vo,set	-	2% Vo,set	Vin=12 V, full load	
Load Regulation	-	0.1% Vo,set	-		
Line Regulation	-	0.1% Vo,set	-		
Regulation Over Temperature (-40 °C to +85 °C)	-	0.3% Vo,set	-	Tref=Ta, min to Ta, max	
Output Current	0 A	-	10 A		
Current Limit Threshold	-	200% Io	-		
Short Circuit Surge Transient	-	1 A ² s	3 A ² s		
Ripple and Noise (pk-pk)	-	50 mV	100 mV	Tested with 0-20 MHz, with 10 uF tantalum capacitor & 1 uF ceramic capacitor	
Ripple and Noise (rms)	-	20 mV	40 mV		
Turn on Time	-	6 mS	10 mS		
Overshoot at Turn on	-	-	1% Vo,set		
Output Capacitance	-	-	5000 uF		
Transient Response					
50% ~ 100% Max Load	Vo = 0.75 V - 5 V	-	100 mV	-	di/dt=2.5 A/uS; Vin=12 V; and with 2 × 150 uF polymer capacitors at the output
Settling Time		-	50 uS	-	
100% ~ 50% Max Load		-	100 mV	-	
Settling Time		-	50 uS	-	

Note: All specifications are typical at nominal input, full load at 25 °C unless otherwise stated.

NON-ISOLATED DC/DC CONVERTERS

8.3 V-14 V Input

0.75 V-5.0 V/10 A Output



General Specifications

Parameter	Min	Typ	Max	Notes
Efficiency				Measured at Vin=12 V, full load
Vo=5.0 V	-	95%	-	
Vo=3.3 V	-	93%	-	
Vo=2.5 V	-	92%	-	
Vo=1.8 V	-	90%	-	
Vo=1.5 V	-	89%	-	
Vo=1.2 V	-	87.5%	-	
Vo=0.75 V	-	81%	-	
Switching Frequency	265 kHz	300 kHz	335 kHz	
Over Temperature Shutdown ¹	-	130 °C	-	
Output Voltage Trim Range	0.7525 V	-	5.0 V	
Remote Sense Compensation	-	-	0.5 V	
MTBF	4,982,651 hours			Calculated Per Bell Core SR-332 (Io = 80% Io,max; Vo=5 V; Vin=12 V; Ta = 25°C)
Dimensions				
Inches (L x W x H)	1.3 x 0.53 x 0.315			
Millimeters (L x W x H)	33.02 x 13.46 x 8.00			
Weight	-	8 g	-	

Note: All specifications are typical at 25 °C unless otherwise stated.

1. The Tref temperature measurement location:

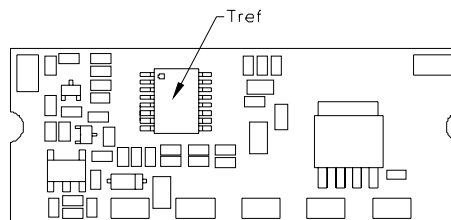

Control Specifications

Parameter	Min	Typ	Max	Notes
Remote On/Off				
Signal Low (Unit Off)	-0.2 V	-	0.3 V	SRBC-10A2A0; Remote On/Off pin open, Unit on.
Signal High (Unit On)	-	-	Vin, max	
Signal Low (Unit On)	-0.2 V	-	0.3 V	SRBC-10A2AL; Remote On/Off pin open, Unit on.
Signal High (Unit Off)	2.5 V	-	Vin, max	
Voltage Sequencing				
Sequencing Delay Time	10 mS	-	-	Delay from Vin, min to application of voltage on SEQ pin
Sequencing Slew Rate Capability	-	-	2 V/mS	Vin, min to Vin, max; Io, min to Io, max; Vseq<Vo
Tracking Accuracy				
Power-Up	-	100 mV	200 mV	
Power-Down	-	300 mV	500 mV	

NON-ISOLATED DC/DC CONVERTERS

8.3 V-14 V Input

0.75 V-5.0 V/10 A Output



Output Trim Equations

Equation for calculating the trim resistor (in Ω) given the desired adjusted voltage (V_{adj}) is shown below. The Trim Up resistor should be connected between the Trim pin and Ground.

$$R_{trimup} = \frac{10500}{V_{adj} - 0.7525} - 1000$$

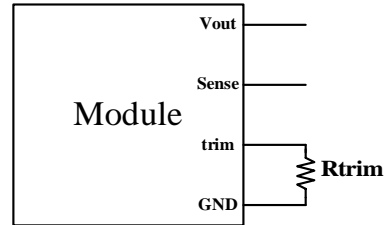

Equation for calculating the trim voltage (in V) given the desired adjusted voltage (V_{adj}) is shown below. The Trim Up voltage should be connected between the Trim pin and Ground.

$$V_{trimup} = 0.7 - 0.0667 \times (V_{adj} - 0.7525)$$

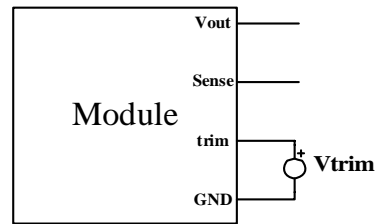

Thermal Derating Curves

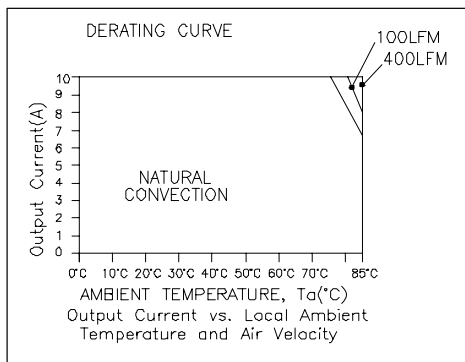

$V_o=0.75$ V

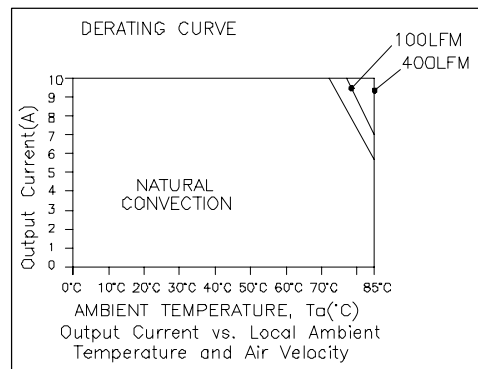

$V_o=1.8$ V

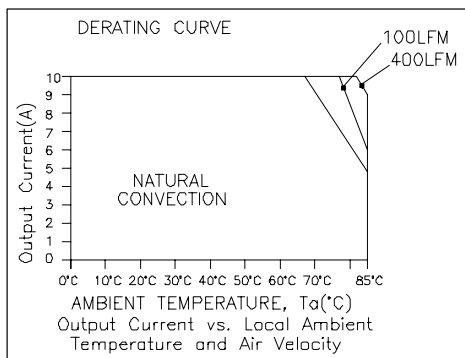

$V_o=3.3$ V

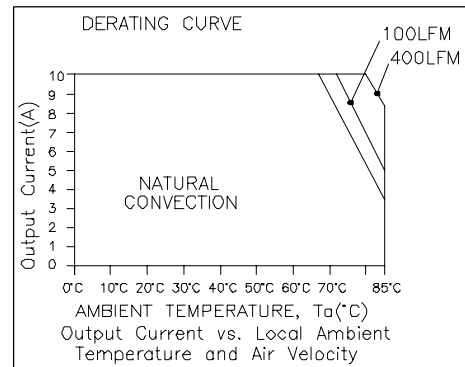

$V_o=5.0$ V

NON-ISOLATED DC/DC CONVERTERS

8.3 V-14 V Input

0.75 V-5.0 V/10 A Output



Efficiency Data

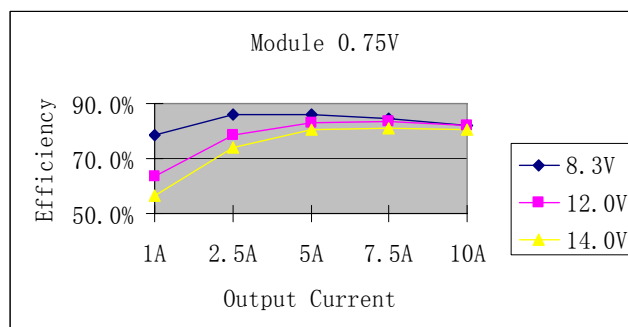
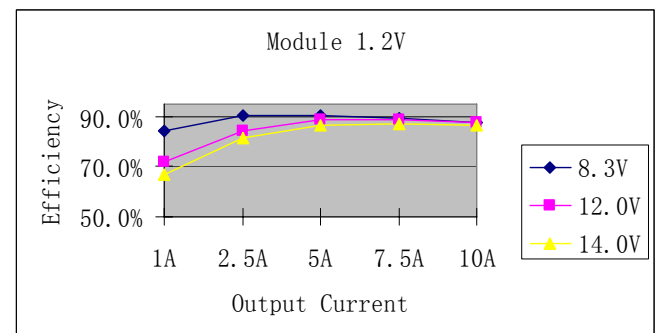
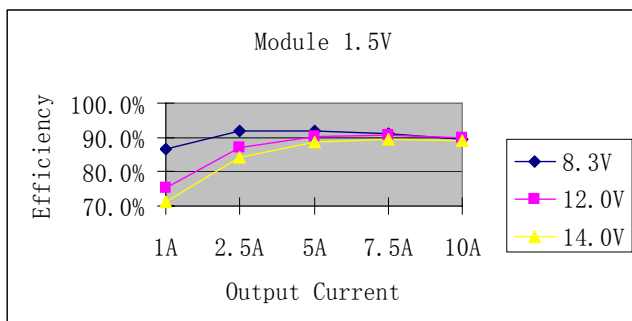
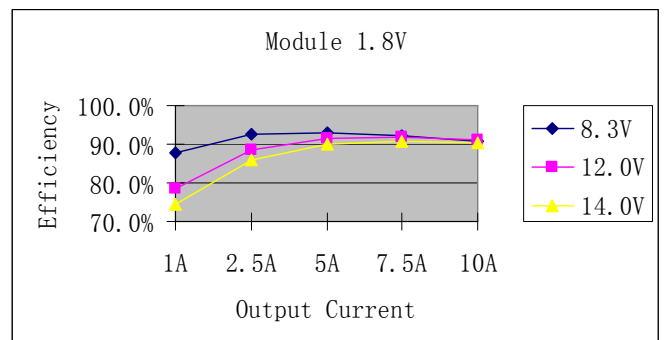
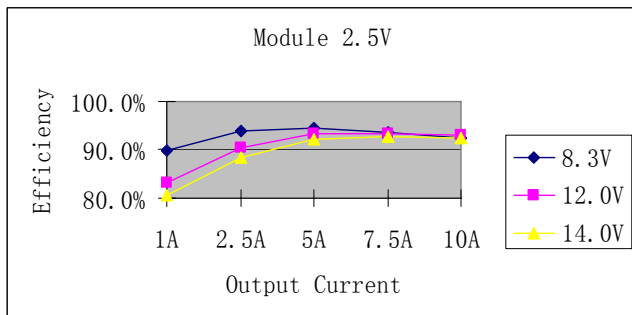
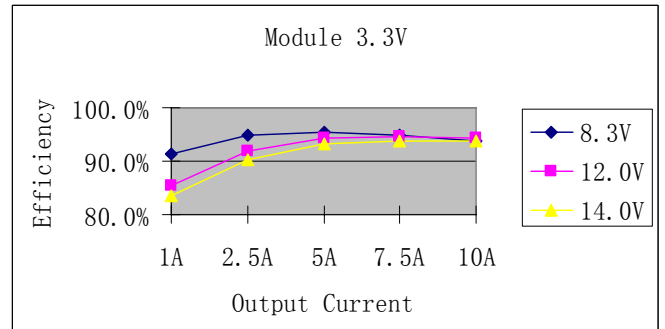
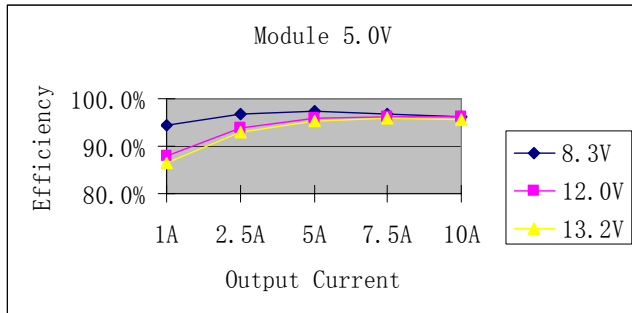

NON-ISOLATED DC/DC CONVERTERS

8.3 V-14 V Input 0.75 V-5.0 V/10 A Output

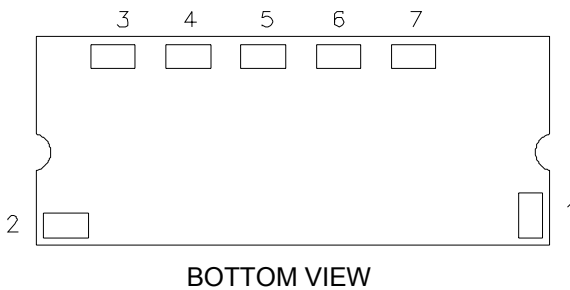
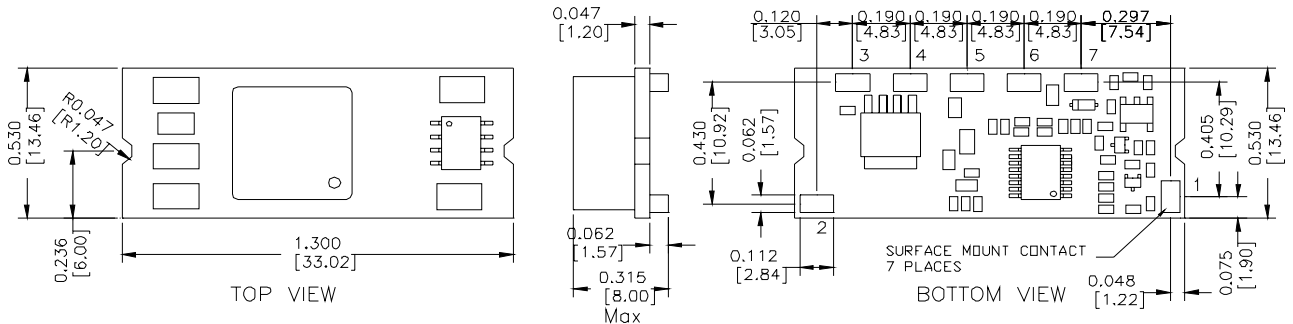

Pin Connections

Pin	Function
1	Remote On/Off
2	Vin+
3	SEQ
4	Ground
5	Vout+
6	Trim
7	Remote Sense

RECOMMENDED PAD LAYOUT

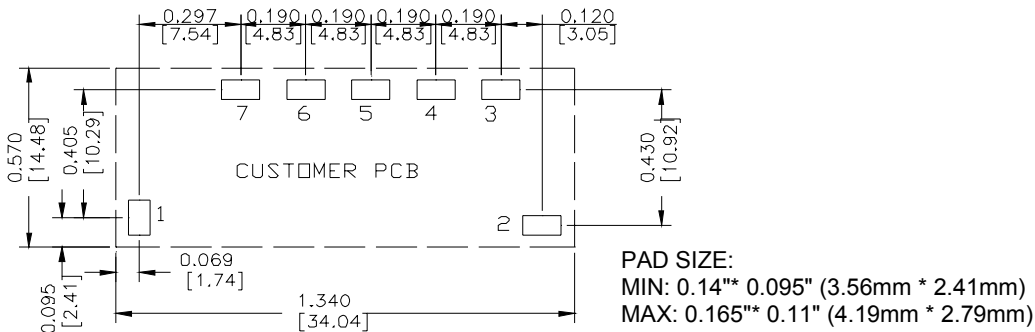

RoHS Compliance

Complies with the European Directive 2002/95/EC, calling for the elimination of lead and other hazardous substances from electronic products.



©2005 Bel Fuse Inc. Specifications subject to change without notice. 090105

CORPORATE

Bel Fuse Inc.
 206 Van Vorst Street
 Jersey City, NJ 07302
 Tel 201-432-0463
 Fax 201-432-9542
www.belfuse.com

FAR EAST

Bel Fuse Ltd.
 8F/ 8 Luk Hop Street
 San Po Kong
 Kowloon, Hong Kong
 Tel 852-2328-5515
 Fax 852-2352-3706
www.belfuse.com

EUROPE

Bel Fuse Europe Ltd.
 Preston Technology Management Centre
 Marsh Lane, Suite G7, Preston
 Lancashire, PR1 8UD, U.K.
 Tel 44-1772-556601
 Fax 44-1772-888366
www.belfuse.com